



SYSTEMS



Facciate continue
Curtain walls





Indice

Index

Il nostro ecosistema	<i>Our ecosystem</i>	p. 05
Le nostre linee	<i>Our product lines</i>	p. 08
Linea Minimale	<i>Minimal line</i>	p. 12
Linea Montanti-traversi	<i>Stick system curtain walling</i>	p. 18
Linea Storefront	<i>Storefront line</i>	p. 24
Linea Windows wall	<i>Windows wall line</i>	p. 30
Linea Strutturali-semistrutturali	<i>Bonded glazing facade</i>	p. 36
Linea a Cellule	<i>Unitised construction curtain walling</i>	p. 42
Linea Ventilata	<i>Ventilated facade</i>	p. 48
Linea Apribili in facciata	<i>Windows for curtain walling</i>	p. 54
Tipologie di aperture	<i>Opening typologies</i>	p. 60
Prestazioni	<i>Performances</i>	p. 62
Prestazioni Linea apribili in facciata	<i>Windows for curtain walling performances</i>	p. 64
Prestazioni USA	<i>USA performance</i>	p. 66



Il nostro ecosistema

Our ecosystem

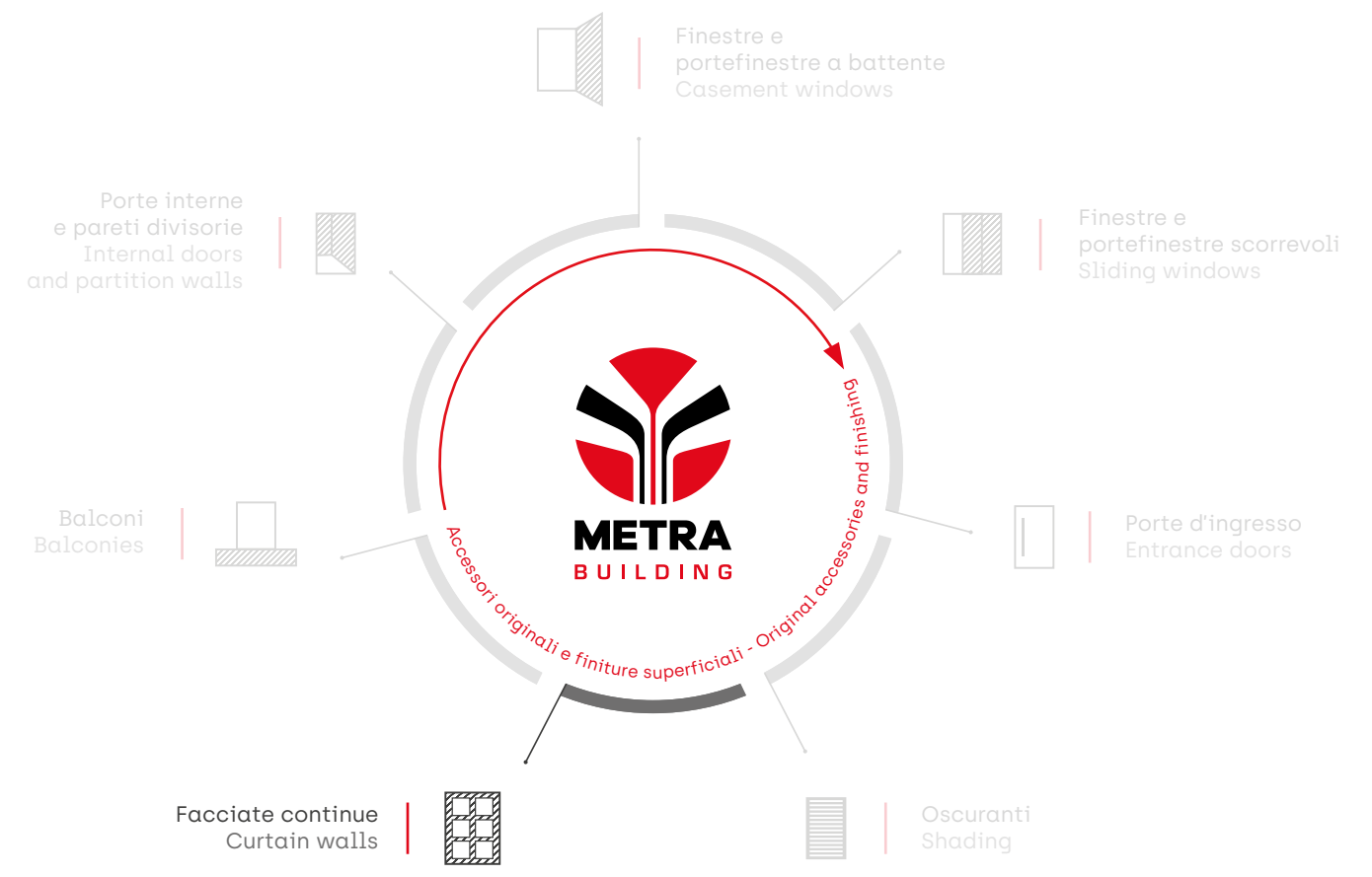

Qualità certificata
 Certified quality



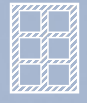

Facciate continue
Curtain walls





Le nostre linee Our product lines



Linea Minimale
Minimal line



Linea Montanti-traversi
Stick system curtain walling



Linea Storefront
Storefront line



Linea Windows wall
Windows wall line



Linea Strutturali-semistrutturali
Bonded glazing facade



Linea a Cellule
Unitised construction curtain walling



Linea Ventilata
Ventilated facade



Linea Apribili in facciata
Windows for curtain walling



Le nostre linee

Our product lines

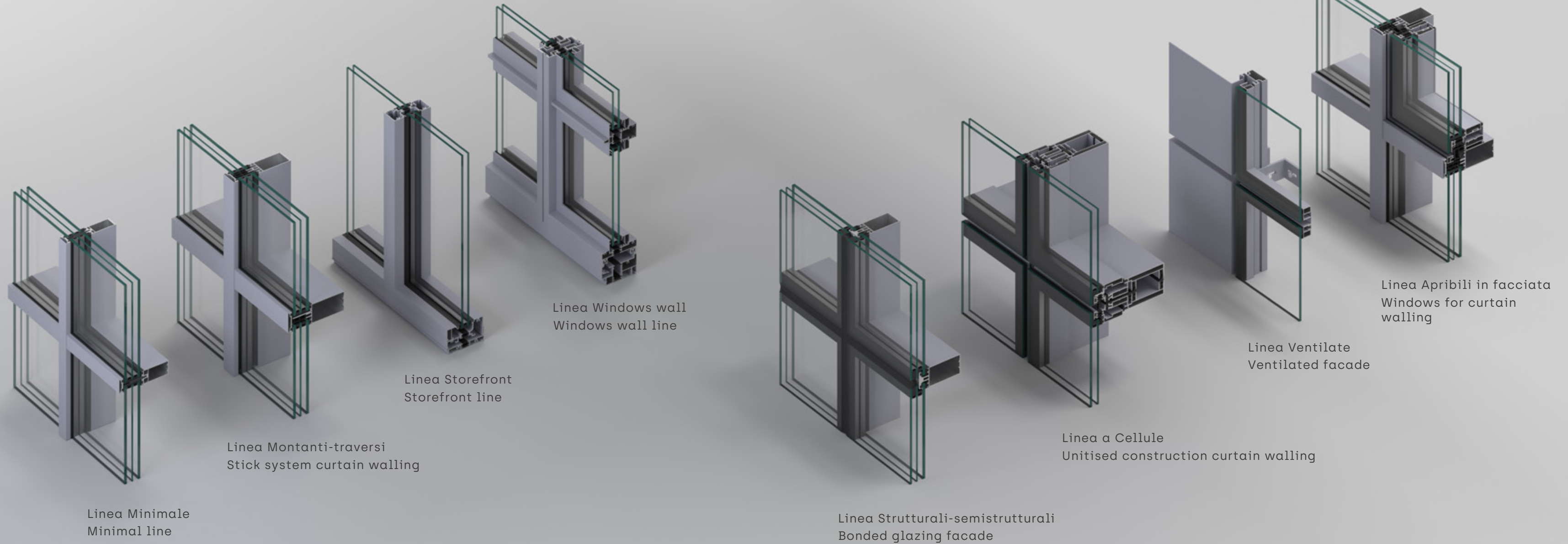



Facciate continue
Curtain walls

Linea Minimale
Minimal Line

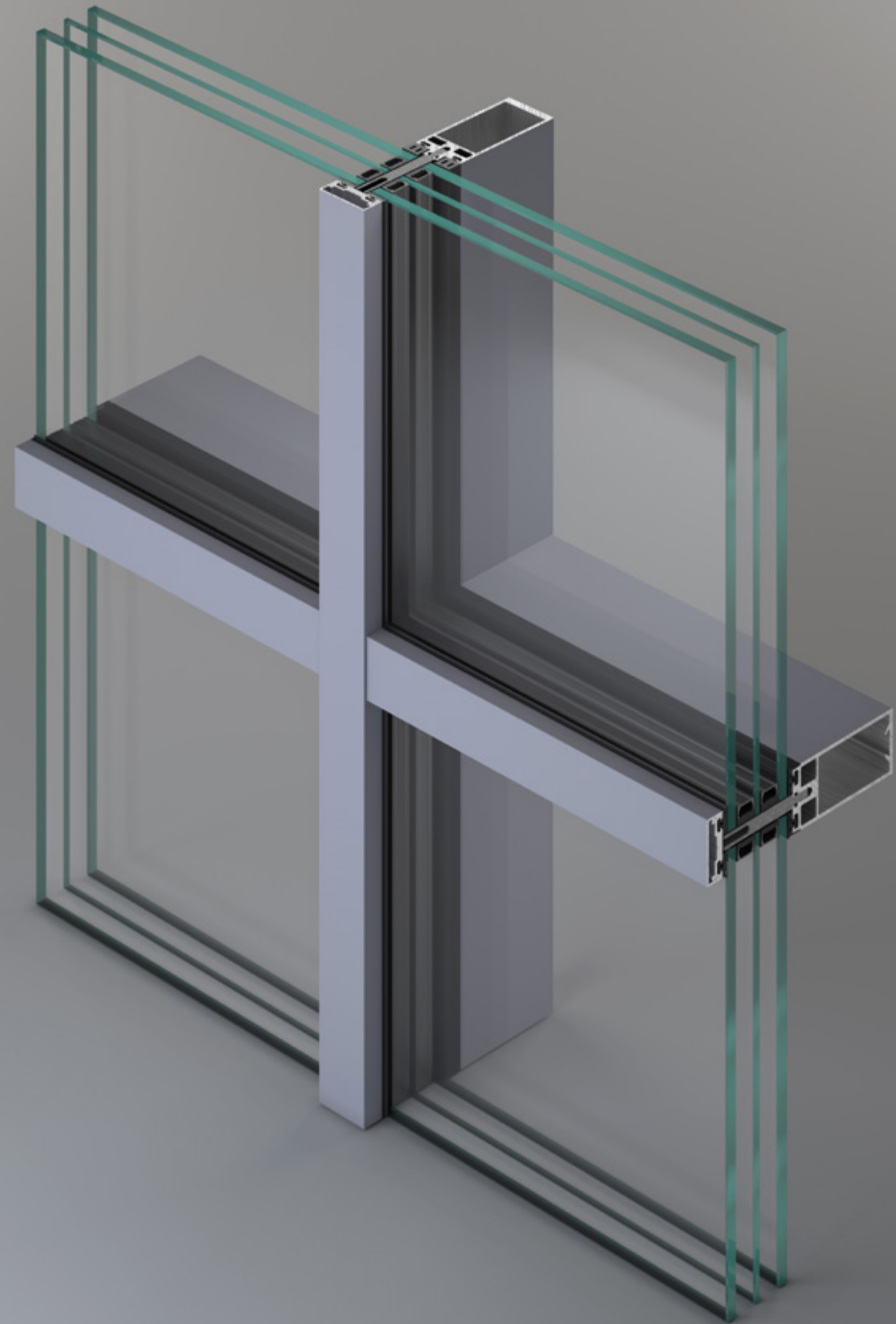



Facciate continue
Curtain walls

Linea Minimale
Minimal Line

SERIE / SERIES POLIEDRA SKY 35 LUX

POLIEDRA SKY 35 LUX

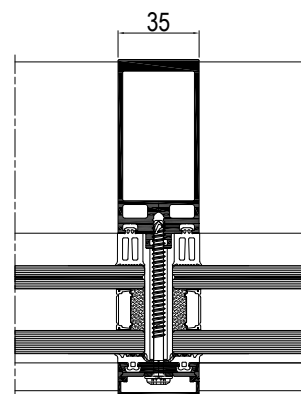

Montanti <i>Mullions</i>	Traversi <i>Transoms</i>	Spessore vetri <i>Glass thickness</i>
larghezza 35 mm profondità da 75 a 150 mm <i>width 35 mm depth from 75 to 150 mm</i>	larghezza 35 mm profondità da 74 a 149 mm <i>width 35 mm depth from 74 to 149 mm</i>	da 24 a 60 mm <i>from 24 to 60 mm</i>





Facciate continue
Curtain walls

Linea Montanti-traversi
Stick system curtain
walling

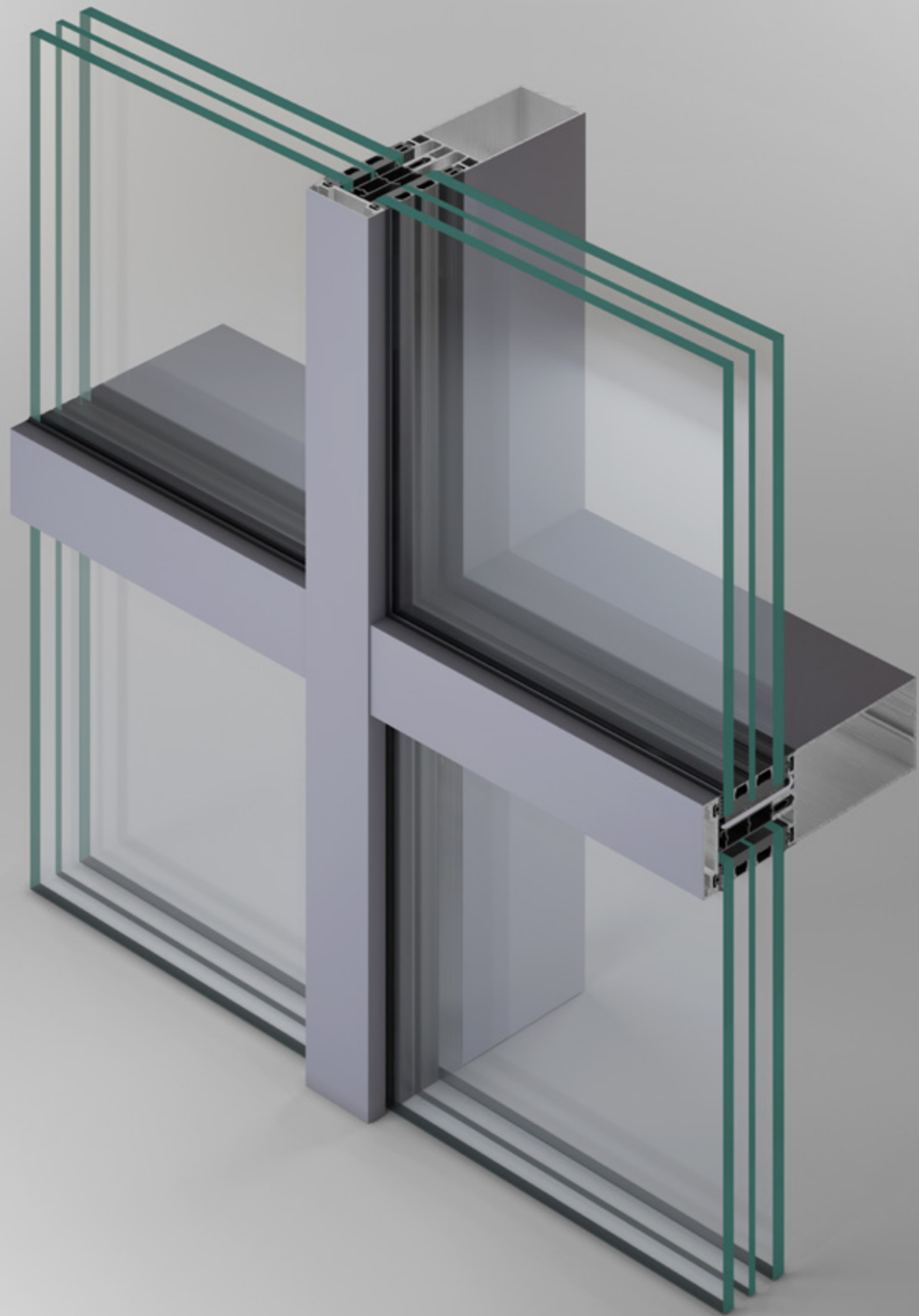



SERIE / SERIES POLIEDRA SKY TECH

POLIEDRA SKY TECH 50

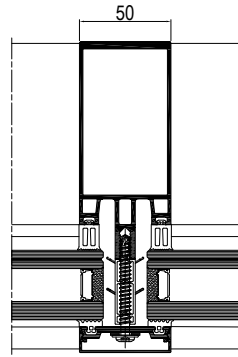

Montanti Mullions	Traversi Transoms	Spessore vetri Glass thickness
larghezza 50 mm profondità da 50 a 250 mm width 50 mm depth from 50 to 250 mm	larghezza 50 mm profondità da 6,5 a 249 mm width 50 mm depth from 6,5 to 249 mm	da 8 a 72 mm from 8 to 72 mm

POLIEDRA SKY TECH 50 IV

IV livello / IV level

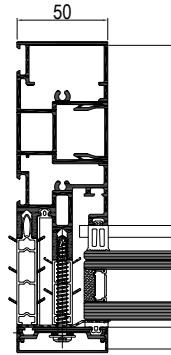

Montanti Mullions	Traversi Transoms	Spessore vetri Glass thickness
larghezza 50 mm profondità da 100 a 150 mm width 50 mm depth from 100 to 150 mm	larghezza 50 mm profondità da 99 a 149 mm width 50 mm depth from 99 to 149 mm	da 18 a 60 mm from 18 to 60 mm

POLIEDRA SKY TECH 60 INW

Apertura interna / Inward opening

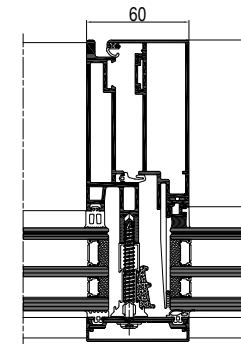

Montanti Mullions	Traversi Transoms	Spessore vetri Glass thickness
larghezza 60 mm profondità da 75 a 150 mm width 60 mm depth from 75 to 150 mm	larghezza 60 mm profondità 74 o 99 mm width 60 mm depth 74 or 99 mm	da 32 a 48 mm from 32 to 48 mm

POLIEDRA SKY 60 CW

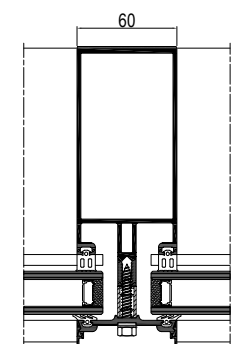

Montanti Mullions	Traversi Transoms	Spessore vetri Glass thickness
larghezza 60 mm profondità da 50 a 250 mm width 60 mm depth from 50 to 250 mm	larghezza 60 mm profondità da 49 a 249 mm width 60 mm depth from 49 to 249 mm	da 8 a 45 mm from 8 to 45 mm

POLIEDRA SKY TECH 60

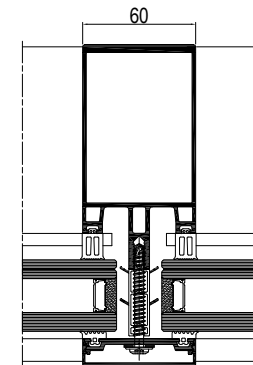

Montanti Mullions	Traversi Transoms	Spessore vetri Glass thickness
larghezza 60 mm profondità da 50 a 250 mm width 60 mm depth from 50 to 250 mm	larghezza 60 mm profondità da 6,5 a 249 mm width 60 mm depth from 6,5 to 249 mm	da 8 a 72 mm from 8 to 72 mm

POLIEDRA SKY TECH 60 ACW

Sottostruttura / Substructure

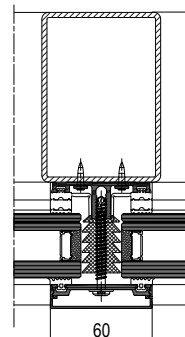

Montanti Mullions	Traversi Transoms	Spessore vetri Glass thickness
larghezza 60 mm profondità 6 mm width 60 mm depth 6 mm	larghezza 60 mm profondità 6 mm width 60 mm depth 6 mm	da 30 a 66 mm from 30 to 66 mm

POLIEDRA SKY TECH 50 CV

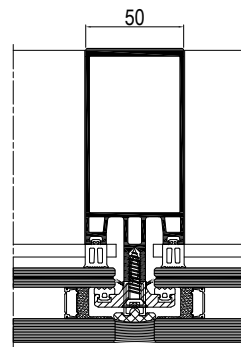

Montanti Mullions	Traversi Transoms	Spessore vetri Glass thickness
larghezza 50 mm profondità da 50 a 250 mm width 50 mm depth from 50 to 250 mm	larghezza 50 mm profondità da 6,5 a 249 mm width 50 mm depth from 6,5 to 249 mm	da 28 a 72 mm from 28 to 72 mm

POLIEDRA SKY TECH 60 CV

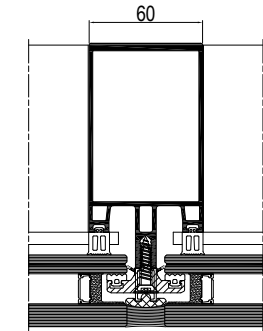

Montanti Mullions	Traversi Transoms	Spessore vetri Glass thickness
larghezza 60 mm profondità da 50 a 250 mm width 60 mm depth from 50 to 250 mm	larghezza 60 mm profondità da 6,5 a 249 mm width 60 mm depth from 6,5 to 249 mm	da 28 a 72 mm from 28 to 72 mm



Facciate continue
Curtain walls

Linea Storefront
Storefront Line

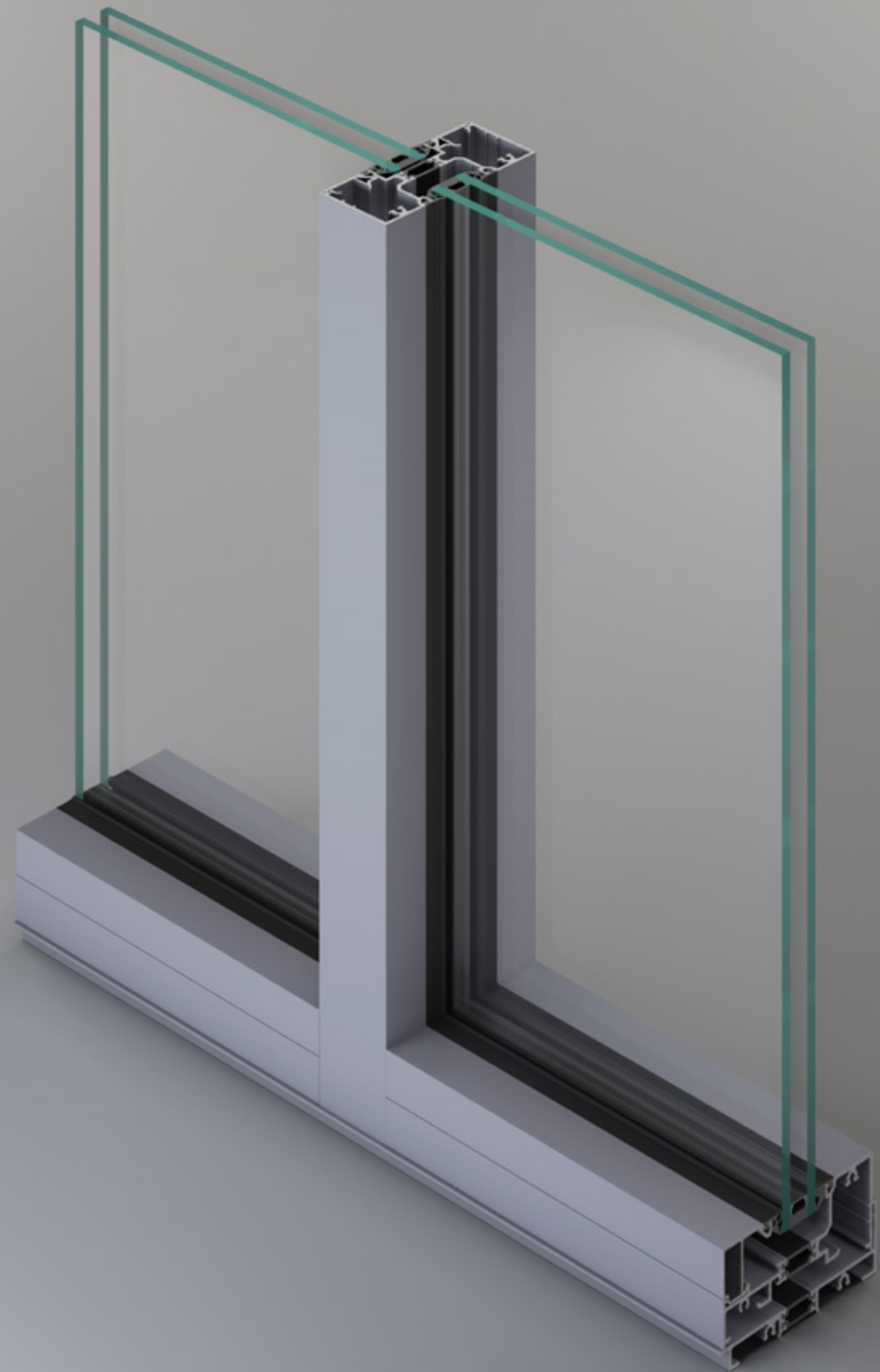



Facciate continue
Curtain walls

Linea Storefront
Storefront Line

SERIE / SERIES NC 115 SF

NC 115 SF

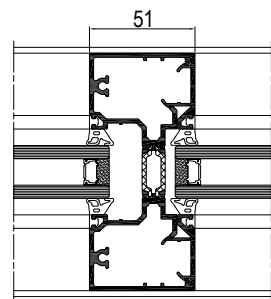

Montanti <i>Mullions</i>	Traversi <i>Transoms</i>	Spessore vetri <i>Glass thickness</i>
larghezza 51 mm profondità 114 mm <i>width 51 mm depth 114 mm</i>	larghezza 50,8 mm profondità 114 mm <i>width 50,8 mm depth 114 mm</i>	25,4 o 31,7 mm <i>25,4 or 31,7 mm</i>





Facciate continue
Curtain walls

Linea Windows wall
Windows wall line

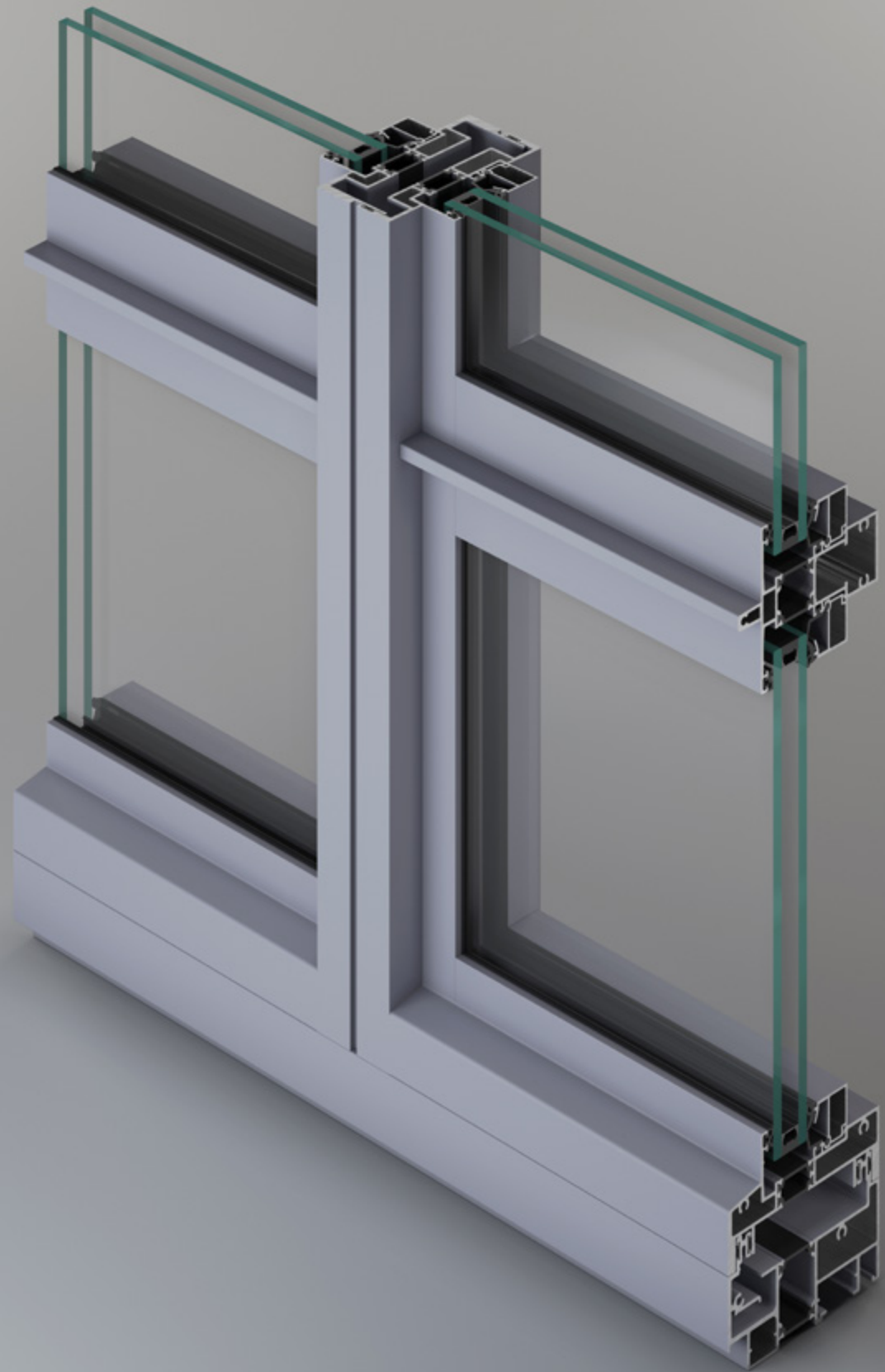



Facciate continue
Curtain walls

Linea Windows wall
Windows wall line

SERIE / SERIES NC 135 WW

NC 135 WW

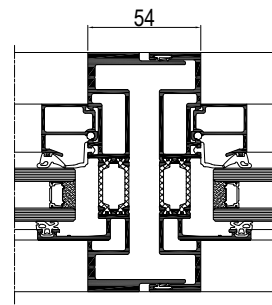

Montanti
Mullions

larghezza 54 mm
profondità 114 mm
width 54 mm
depth 114 mm

Traversi
Transoms

larghezza 36 mm
profondità 105,6 mm
width 36 mm
depth 105,6 mm

Spessore vetri
Glass thickness

da 10 a 32 mm
from 10 to 32 mm





Facciate continue
Curtain walls

Linea
Strutturali-semistrutturali
Bonded glazing facade





Facciate continue
Curtain walls

Linea Strutturali-semistrutturali
Bonded glazing facade

SERIE / SERIES POLIEDRA SKY TECH

POLIEDRA SKY 50 S

Strutturale / Structural

Semistrutturale / Semi-structural

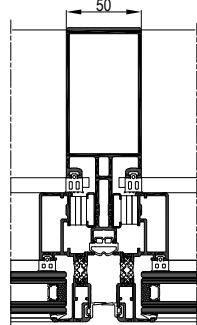
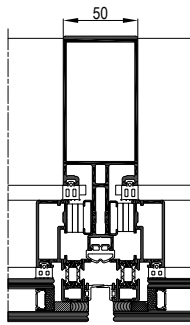

Montanti <i>Mullions</i>	Traversi <i>Transoms</i>	Spessore vetri <i>Glass thickness</i>
larghezza 50 mm profondità da 42 a 225 mm <i>width 50 mm depth from 42 to 225 mm</i>	larghezza 50 mm profondità da 41 a 199 mm <i>width 50 mm depth from 41 to 199 mm</i>	24 a 32 mm <i>24 to 32 mm</i>





Facciate continue
Curtain walls

Linea a Cellule
Unitised construction
curtain walling

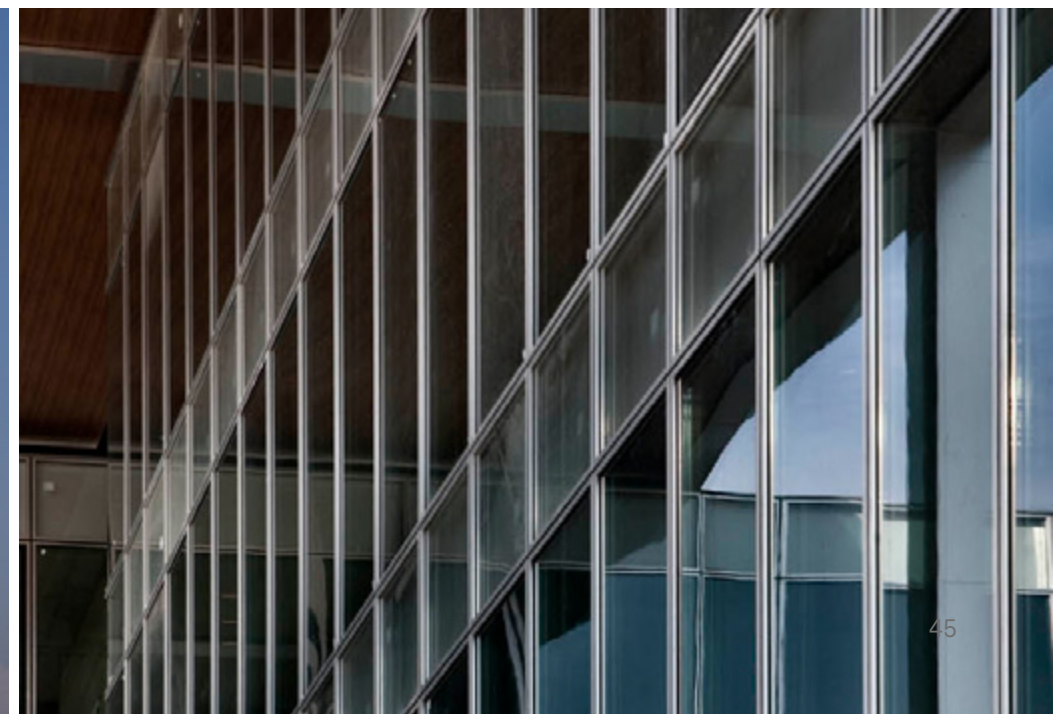
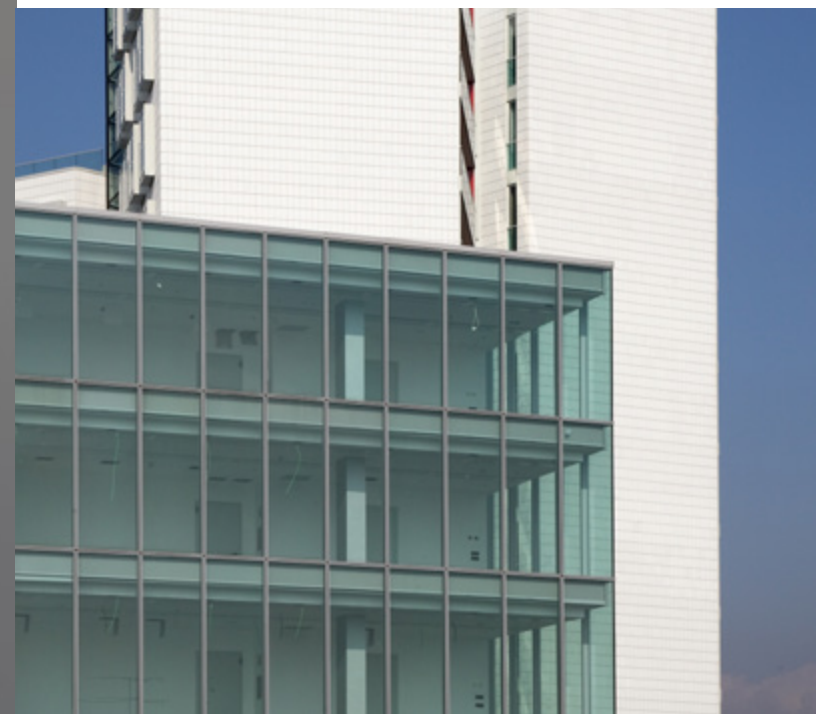
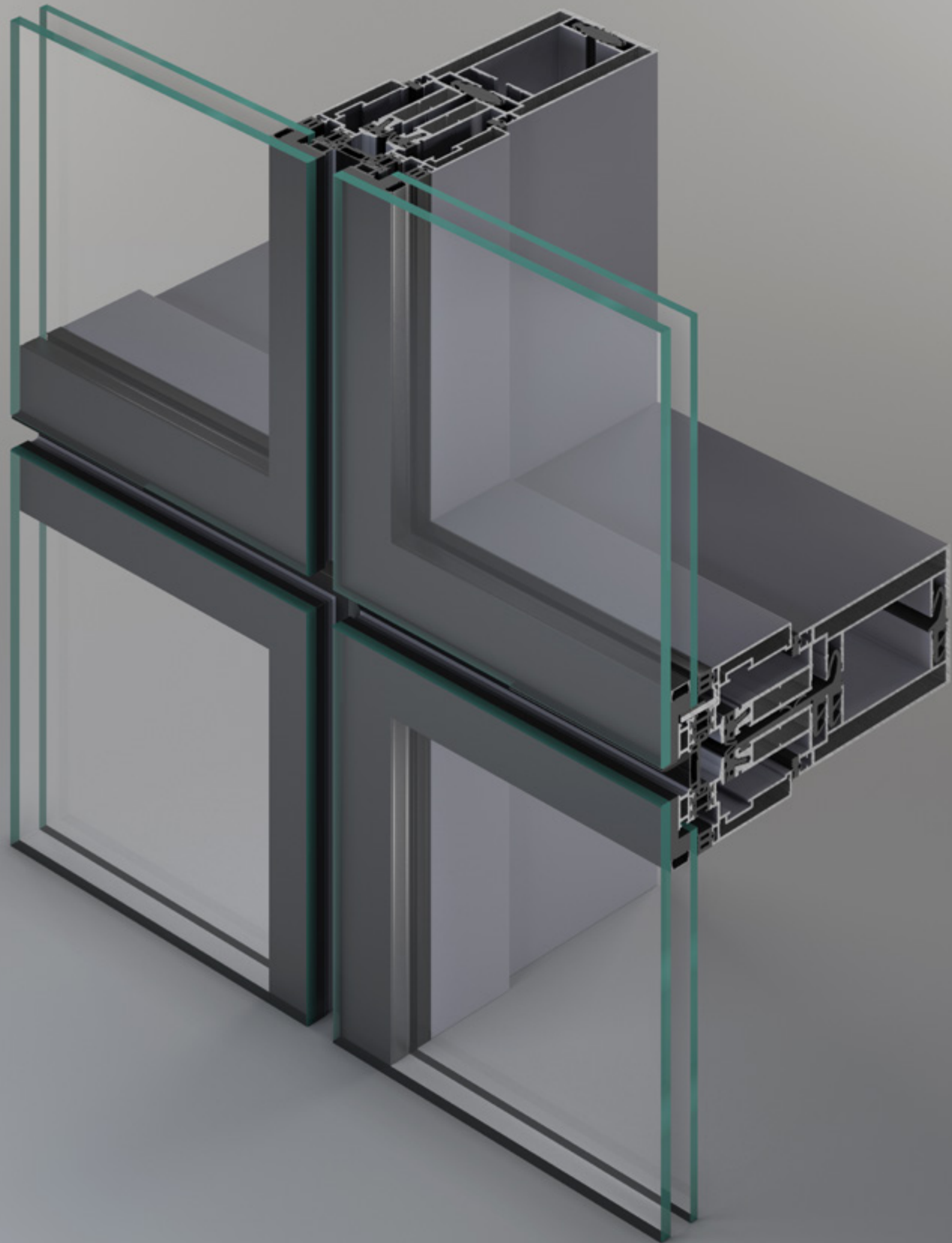



Facciate continue
Curtain walls

Linea a Cellule
Unitised construction curtain walling

SERIE / SERIES POLIEDRA SKY FAST 80

POLIEDRA SKY FAST 80

Strutturale / Strutturale

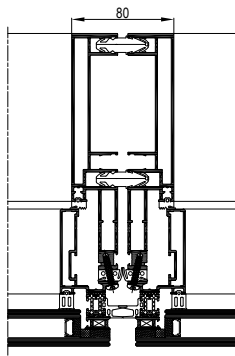

Fermavetro / Glazing bead

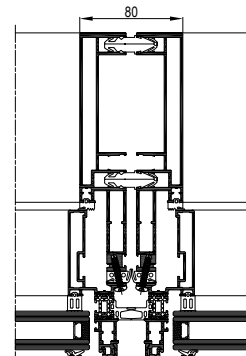

Montanti Mullions	Traversi Transoms	Spessore vetri Glass thickness
larghezza 80 mm profondità da 131,5 mm width 80 mm depth from 131,5 mm	larghezza 80 mm profondità da 50 a 130,5 mm width 80 mm depth from 50 to 130,5 mm	da 30 a 42 mm from 30 to 42 mm





Facciate continue
Curtain walls

Linea Ventilata
Ventilated facade

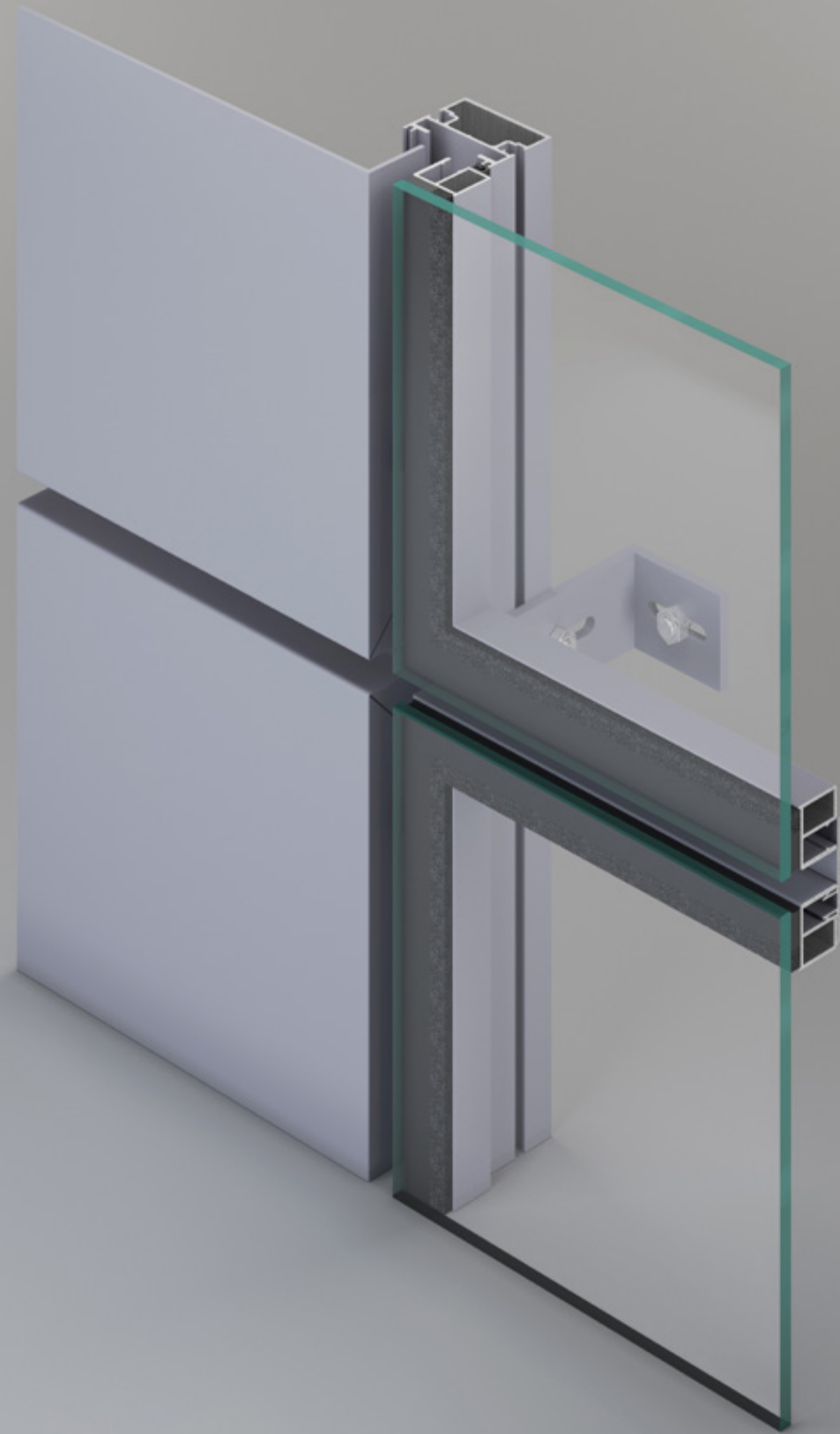



Facciate continue
Curtain walls

Linea Ventilate
Ventilated facade

SERIE / SERIES URANO WALL

URANO WALL

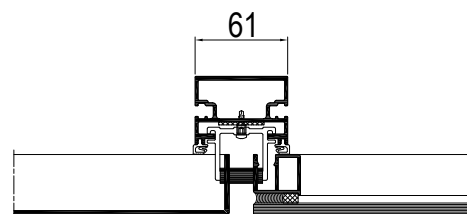

Profilati verticali portapannelli
Vertical panel holder profiles

da 29 a 67 mm
from 29 to 67 mm





Facciate continue
Curtain walls

Linea apribili in facciata
Windows for curtain walling

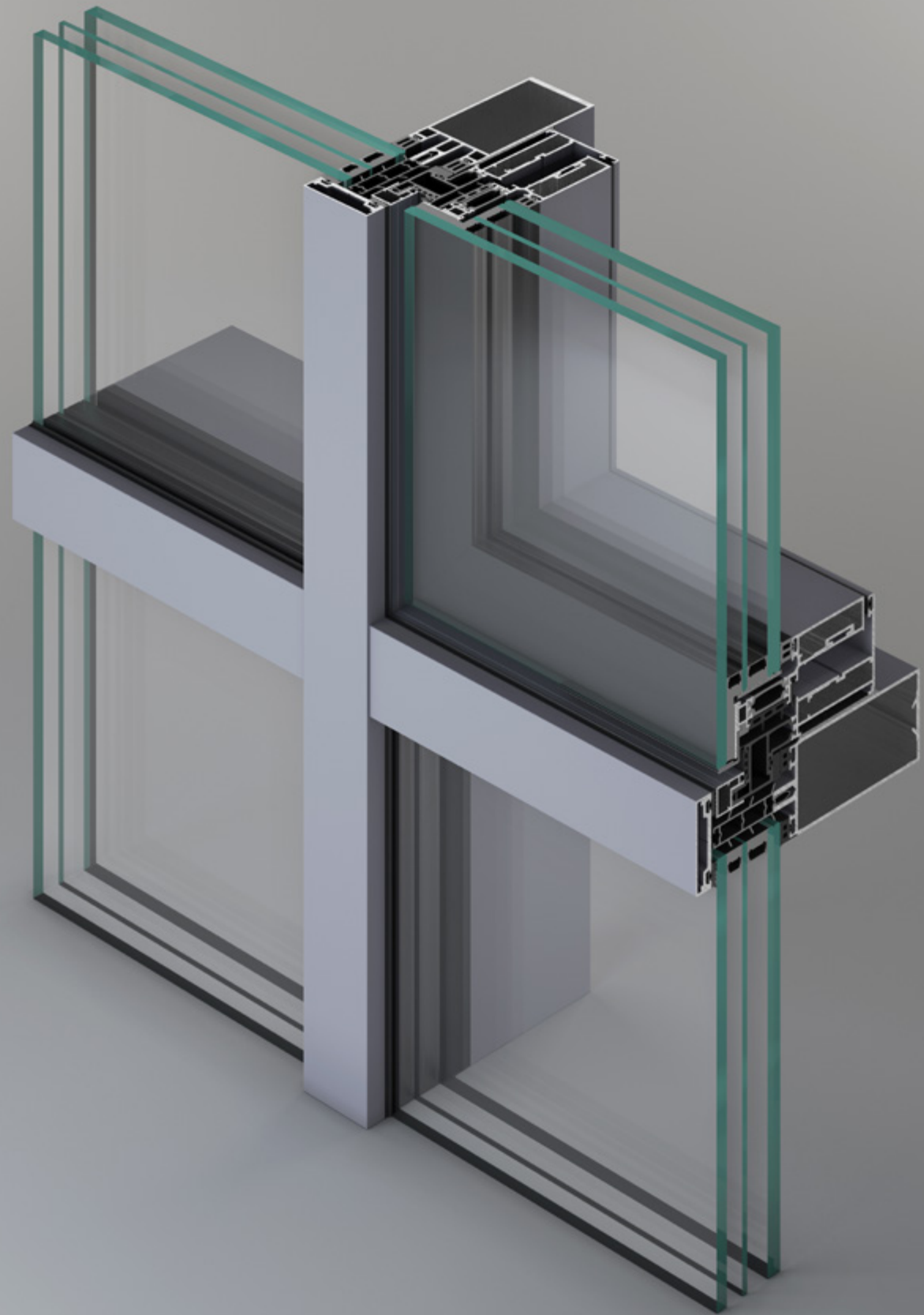



Facciate continue
Curtain walls

Linea Apribili in facciata
Windows for curtain walling

FINESTRE PER FACCIATE / WINDOWS FOR CURTAIN WALLS

FINESTRE PER FACCIATE WINDOWS FOR CURTAIN WALLS

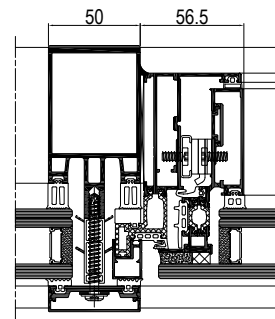

Telaio fisso Frame	Telaio mobile Sash	Spessore vetri Glass thickness
soluzione a sporgere 100 o 114 mm soluzione a nastro 90 o 104 mm top-hung solution 100 or 114 mm ribbon solution 90 or 104 mm	soluzione strutturale 87 o 101 mm soluzione strutturale vetro piano 69 mm soluzione semi-strutturale 109 o 123 mm soluzione vetro ad infilare 89 o 103 mm structural solution 87 o 101 mm structural solution flat glass 69 mm semi-structural solution 109 or 123 mm inserted glass solution 89 or 103 mm	da 28 a 62 mm from 28 to 62 mm

FINESTRE PER LUCERNARI ROOFS WINDOWS

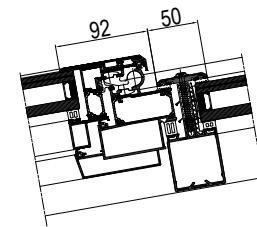

Telaio fisso Frame	Telaio mobile Sash	Spessore vetri Glass thickness
97,5 mm	77 o 99,5 mm 77 or 99,5 mm	da 27 a 58 mm from 27 to 58 mm

SERIE / SERIES NC 96 CW

NC 96 CW OUT

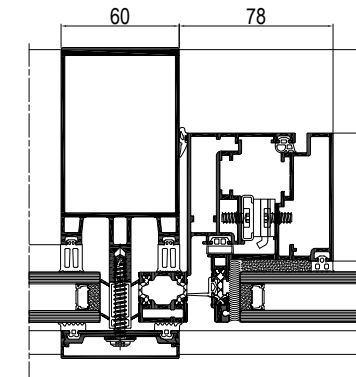

Telaio fisso Frame	Telaio mobile Sash	Spessore vetri Glass thickness
96 mm o 100,6 mm 96 mm or 100,6 mm	96 mm o 100,6 mm 96 mm or 100,6 mm	25,4 mm o 30 mm 25,4 mm or 30 mm

NC 96 CW

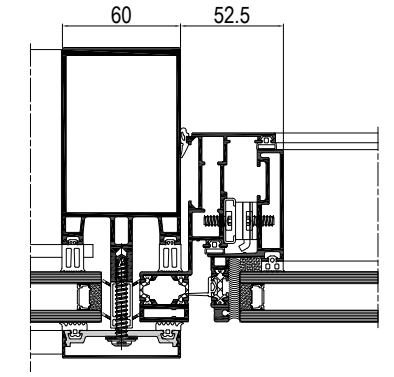

Telaio fisso Frame	Telaio mobile Sash	Spessore vetri Glass thickness
96 mm o 100,6 mm 96 mm or 100,6 mm	87,5 mm o 92 mm o 96 mm o 100,6 mm 87,5 mm o 92 mm o 96 mm o 100,6 mm	25,4 mm o 30 mm 25,4 mm or 30 mm



Facciate continue
Curtain walls

Linea Apribili in facciata
Windows for curtain walling

Tipologie di aperture

Opening typologies

Facciate continue
Curtain walls

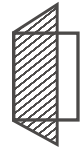

Battente
Casement



Vasistas
Bottom hung casement

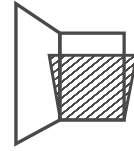

Anta ribalta
Tilt-and-turn



Sporgere
Projecting



Apertura in parallelo
Parallel opening



Specchiature fisse
Fixed lights



Anta a battente apertura esterna
Outward opening casement





Prestazioni Performances

Tenuta all'acqua statica Static Water tightness EN 12154 EN 12155

Pressione d'aria applicata <i>Air pressure applied</i>	(150Pa)	(300Pa)	(450Pa)	(600Pa)	(>900Pa)	(1200Pa)
Km/h	55,77	78,87	96,59	111,54	111,54	158
Fino a / Up to	R4	R5	R6	R7	RE1050	RE1200

Linea Minimale / Minimal line - Linea Strutturali-Semistrutturali / Bonded Glazing Facade-
Linea Montali-Traversi / Stick System Curtain Walling [tranne POLIEDRA SKY 60 CW]: **Classe RE1200**
Linea Montali-Traversi / Stick System Curtain Walling [POLIEDRA SKY TECH 60 INW | Apertura interna]-
Linea a Cellule / Unitised Construction Curtain Walling: **Classe R7**

Tenuta all'acqua dinamica Dynamic Water tightness EN 13050

Pressione raggiunta senza infiltrazioni <i>Dynamic Water tightness</i>	(300Pa)	(450Pa)	(600Pa)	(750Pa)	(1200Pa)
Fino a Km/h / Up to Km/h	78,87	96,59	111,54	124,7	158

Linea Minimale / Minimal line - Linea Montali-Traversi / Stick System Curtain Walling
[tranne POLIEDRA SKY 60 CW e POLIEDRA SKY TECH 60 INW | Apertura interna] : **750Pa**
Linea a Cellule / Unitised Construction Curtain Walling: **600Pa**

Resistenza all'effrazione Burglar resistance EN 1627 - EN 1630

Fino a / Up to	RC1	RC2	RC3

Linea Minimale / Minimal line: **Classe RC2**

Resistenza al vento Resistance to wind load EN 12179 - EN 13116

Carico di progetto <i>Design load</i>	(2000Pa)	(1400Pa)	(1200Pa)
Carico di sicurezza <i>Safety load</i>	(3000Pa)	(2100Pa)	(1800Pa)

Linea Minimale / Minimal line - Linea Montali-Traversi / Stick System Curtain Walling
[tranne POLIEDRA SKY 60 CW] : **2000Pa**
Linea Montali-Traversi / Stick System Curtain Walling [POLIEDRA SKY TECH 60 INW |
Apertura interna] - Linea a Cellule / Unitised Construction Curtain Walling: **1200Pa**

Permeabilità all'aria Air permeabilit EN 12152 - EN 12153

Pressione d'aria applicata <i>Air pressure applied</i>	(150Pa)	(300Pa)	(450Pa)	(600Pa)	(>600Pa)
Fino a / Up to	A1	A2	A3	A4	AE

Linea Minimale / Minimal line - Linea Montali-Traversi / Stick System Curtain Walling
[tranne POLIEDRA SKY 60 CW]: **Classe AE**
Linea Montali-Traversi / Stick System Curtain Walling [POLIEDRA SKY TECH 60 INW | Apertura interna]-
Linea a Cellule / Unitised Construction Curtain Walling - Linea Strutturali-Semistrutturali / Bonded
Glazing Facade: **Classe A4**

Potere fonoisolante Soundproofing power EN ISO 10140-3 - EN ISO 717-1

fino a **50 dB** - up to **50 dB**

Linea Minimale / Minimal line - Linea Montali-Traversi / Stick System Curtain Walling [tranne POLIEDRA SKY
60 CW e POLIEDRA SKY TECH 60 INW | Apertura interna]: **50 dB**

Resistenza all'urto Resistance to impact EN 14019

Altezza di caduta / Drop height	200 mm	300 mm	450 mm	700 mm	950 mm
Fino a / Up to	1	2	3	4	5

Linea Minimale / Minimal line - Linea Montali-Traversi / Stick System Curtain Walling
[tranne POLIEDRA SKY 60 CW e POLIEDRA SKY TECH 60 INW | Apertura interna] : **Classe I5/E5**
Linea a Cellule / Unitised Construction Curtain Walling: **Classe I5**

Trasmittanza termica Thermal transmittance

U_t W/m² K





Prestazioni Linea apribili in facciata
Windows for curtain walling performances

Permeabilità all'aria
Air permeability
EN 1026 - EN 12207

Pressione d'aria applicata <i>Air pressure applied</i>	(150Pa)	(300Pa)	(450Pa)	(600Pa)	(750Pa)
Fino a / Up to	1	2	3	4	E

Linea Apribili in facciata / Windows for curtain walling (Finestre per facciate / Windows for curtain walls - Finestre per lucernari) /Roofs windows): **Classe 4**

Tenuta all'acqua
Water tightness
EN 1027 - EN 12208

Pressione d'aria applicata <i>Air pressure applied</i>	(0Pa)	(50Pa)	(100Pa)	(150Pa)	(200Pa)	(250Pa)	(300Pa)	(450Pa)	(600Pa)	(900Pa)	(1500Pa)
Km/h	0	32,2	45,53	55,77	64,39	72	78,87	96,59	111,54	136,6	147,5
Fino a / Up to	1A	2A	3A	4A	5A	6A	7A	8A	9A	E900	E1500

Linea Apribili in facciata / Windows for curtain walling (Finestre per facciate / Windows for curtain walls - Finestre per lucernari) /Roofs windows): **E1500**

Resistenza al vento
Resistance to wind load
EN 12211 - EN 12210

Pressione d'aria applicata <i>Air pressure applied</i>	(400Pa)	(800Pa)	(1200Pa)	(1600Pa)	(2000Pa)	(>2000Pa)
Km/h	A ($\leq 1/150$)				C ($\leq 1/300$)	
Fino a / Up to	1	2	3	4	Exxx	

Linea Apribili in facciata / Windows for curtain walling (Finestre per facciate / Windows for curtain walls): **Classe C4** - (Finestre per lucernari) /Roofs windows): **Classe C2**

Resistenza ai cicli di apertura e chiusura
Resistance to repeated opening and closing cycles
EN 1119 - EN 12400

Fino a / N°di cicli <i>Up to / N° cycles</i>	0	1	2	3	4	5	6	7	8
	-	5000	10000	20000	50000	100000	200000	500000	1000000

Linea Apribili in facciata / Windows for curtain walling (Finestre per facciate / Windows for curtain walls): **Classe 2/10.000**

Forze di azionamento
Operating forces
EN 13115

Fino a / Up to	Classe 0	Classe 1	Classe 2
	-	100 N	30 N

Linea Apribili in facciata / Windows for curtain walling (Finestre per facciate / Windows for curtain walls): **Classe 1**

Resistenza all'effrazione
Burglar resistance
EN 1627 - EN 1630

Fino a / Up to	RC1	RC2	RC3

Linea Apribili in facciata / Windows for curtain walling (Finestre per facciate / Windows for curtain walls): **Classe RC2**



Prestazioni USA
USA performance

POLIEDRA SKY 60 CW
Linea Montanti-traversi
Stick system curtain walling

Tenuta all'acqua statica Static Water tightness ASTM 547 - ASTM E331	Permeabilità all'aria Operating forces ASTM E283	Resistenza al vento Resistance to wind load ASTM E330
720Pa	Qaverage 0,192 L s/m2 @300Pa	Carico di progetto 2875 Pa Design load 2875 Pa Carico di sicurezza 4325Pa Safety load 4325Pa

SERIE NC 135 WW
Linea Windows Wall
Windows wall line

Tenuta all'acqua statica Static Water tightness ASTM 547 - ASTM E331	Tenuta all'acqua dinamica Dynamic Water tightness AAMA 501.1	Permeabilità all'aria Operating forces ASTM E283	Resistenza al vento Resistance to wind load ASTM E330
720Pa	720Pa	Qaverage 0,46 L s/m2 @300Pa	Carico di progetto 3120Pa Design load 3120Pa Carico di sicurezza 4680Pa Safety load 4680Pa

SERIE NC96 CW OUT
Linea Apribili in facciata
Windows for curtain walling

Classificazione Designation AAMA / WDMA / CSA 101 / I.S.2 / A440-05
AP-AW80

SERIE NC96 CW
Linea Apribili in facciata
Windows for curtain walling

Classificazione Designation AAMA / WDMA / CSA 101 / I.S.2 / A440-05
AP-C80 AP-AW80







**METRA S.p.A**

Via Stacca 1,
25050 - Rodengo Saiano
Brescia - Italy
T +39 030 68191

info@metrabuilding.com

METRA RAGUSA S.p.A.

Zona industriale,
97100 - Ragusa
Italy
T +39 0932 660911

info.ragusa@metrabuilding.com

METRA ALUMINIUM INC.

2000, boul. Fortin
Laval, QC H7S 1P3
Canada
T (450) 629-4260

info.canada@metrabuilding.com

METRA USA

Waterford Business Park
5201 Blue Lagoon Drive, Unit #984
Miami, FL 33126 USA
T +1 305-915-0999

info.usa@metrabuilding.com



www.metrabuilding.com